

ISSN 0140 3818

SSSU 3

A BROAD APPRAISAL OF THE ECONOMIC AND  
TECHNICAL REQUISITES FOR A WIND DRIVEN  
MERCHANT VESSEL

J.F. Wellicome

Ship Science Report No. 3

# UNIVERSITY OF SOUTHAMPTON



DEPARTMENT OF SHIP SCIENCE

FACULTY OF ENGINEERING

AND APPLIED SCIENCE

A BROAD APPRAISAL OF THE ECONOMIC AND  
TECHNICAL REQUISITES FOR A WIND DRIVEN  
MERCHANT VESSEL

J.F. Wellicome

Ship Science Report No 3

A BROAD APPRAISAL OF THE ECONOMIC AND TECHNICAL  
REQUISITES FOR A WIND DRIVEN MERCHANT VESSEL

by John Wellicome, B.Sc., Ph.D.

Lecturer in Ship Science  
Southampton University.

Published in OCCASIONAL PUBLICATION NO. 2

"THE FUTURE OF COMMERCIAL SAIL"

A Selection of the Papers Presented at the meeting of the  
Royal Institution of Naval Architects Small Craft Group  
London, 27th November 1975.

# A Broad Appraisal of the Economic and Technical

## Requisites for a Wind Driven Merchant Vessel

John Wellicome, B.Sc., Ph.D. (Member)

Lecturer in Ship Science,  
University of Southampton.

### Summary

The current high level of bunker fuel prices and the prospect of dwindling oil supplies in the comparatively near future may well lead to a reappraisal of the means of propulsion used by commercial ships.

If oil fuel becomes uneconomic the foreseeable alternatives are nuclear power or a return to sail. One could claim that the future of nuclear power is in doubt from long term pollution and safety considerations. It is also true that for technical reasons nuclear power is only suited to large or fast ships requiring 30 000 shp upwards. Thus there may well be grounds for considering a return to sail at least for the transportation of those commodities which do not command a high freight rate.

In the event of a return to sail it would obviously be possible to reintroduce Square and Fore-and-aft rigged vessels similar to those existing at the turn of this century, but with design changes incorporating the use of ancillary power for sail handling purposes. However, during the last 50 years a number of alternative means of achieving wind propulsion have emerged which suggest the possibility of a radically different form of wind propulsion.

The paper is in two parts. Part A is concerned with the current economic prospects of sail as a direct competitor to the oil fueled motor-ship. It is argued that increasing oil costs force down the economic speed of a motor-ship to a point where averaged voyage times may not be significantly better than are achievable under sail and goes on to discuss the operating and constructional costs of a typical general cargo vessel of about 20 000 tonnes displacement as a motor vessel and as a sailing vessel. Part B is concerned with the technical characteristics of ships of this size fitted with several alternative means of wind propulsion each of which has distinctly different operating characteristics. The discussion is limited to the possible aerodynamic and hydrodynamic performance characteristics of the proposed vessels. In particular, there is no discussion of the structural or other engineering problems that could arise with some of the alternatives, nor does it discuss the associated problems in cargo handling that may arise.

### Part A Economic Considerations

An analysis of general cargo ships in service in the world's fleets and currently under construction shows that the majority of these ships are of about 15 000 tonnes deadweight capacity designed to operate at speeds in the range 15-18 kn. Ships of this size and speed require between 7000 and 13000 shp for propulsion purposes. It seems generally accepted that nuclear power is only suitable for installations requiring in excess of 30 000 shp; thus, even discounting the long term safety and pollution aspects of the problem, it would seem unlikely that nuclear power would come into use on ships of this class.

Assuming that the recent 'oil crisis' is a true indication of future trends so that oil fuel will remain a relatively expensive and possibly a scarce form of fuel, there would seem to be a limited number of choices open to the companies currently operating cargo vessels of the size which are now regarded as normal. These are:-

- a) To operate fewer, larger vessels for which nuclear power is a viable form of propulsion
- b) To use coal, manufactured gas fuels such as methane or liquid hydrogen or other fuels currently in use for rocket motors
- c) To use wind power in one form or another.

At this particular time it is not possible to foresee whether in the medium term oil fuel will fall in cost, relative to other commodities, towards its pre-crisis value; nor to foresee which of the three options listed above is the most likely outcome if oil is priced out of the fuel market.

It is interesting, however, to speculate on the possibility that wind driven vessels could compete with oil fuel and to examine the type of vessel that may come into service in the event that such vessels are reintroduced. Some calculations were carried out recently at Southampton University to estimate a year-round average performance for three types of sailing vessel each of 21 000 tonnes displacement over a North Atlantic route and, additionally, to estimate cargo carrying capacity, capital and running costs for these vessels.

Obviously the profitability of the motor-ship depends on the service speed of the vessel. As fuel costs rise so the most economic service speed is forced down and it is a fact that ships are now being operated at speeds 2 or 3 knots below their designed service speed. Many factors conspire to maintain speeds in the current fleet above a strictly economic speed; amongst them the relatively high capital cost of a ship that is over-powered in current economic conditions and the need to maintain a speed sufficiently high to attract cargoes in the face of competition from other operators. For the purpose of comparison it was decided to compare the sailing cargo vessels with a motor-ship operating at a modest 15 knot speed and also with a much slower vessel operating at 10 knots (a speed that may prove to be the future economic speed if oil remains expensive).

The economic analysis was carried out for three differing sailing vessels each of 21 000 tonnes displacement:-

- Vessel A: Monohull with Dynaschiffe rig
- Vessel B: Monohull with rigid wing sail rig
- Vessel C: Catamaran with rigid wing sail rig

#### Service Performance Estimates

Performance estimates for the Dynaschiffe vessel A were available in Beaufort wind strengths force 2 to force 9 based on wind tunnel and tank test data obtained at HSVA and published in Ref. 1. Performance estimates for vessels B and C were made, based on data in Refs. 2 and 3 and normal aerofoil data, corrected to an appropriate equivalent aspect ratio to the chosen rig, over the same range of Beaufort numbers.

Ref. 1 contains a summary of wind data for two North Atlantic areas taken over a forty year period and this data was used to estimate the average service speed for each of these vessels over a typical year when operating over an Atlantic route.

Weight estimates were made for each class of vessel including an estimate of the weights of the wing sail rig proposed for vessels B and C based on a preliminary structural design. From these weight estimates it is possible to estimate the cargo dead-weight capacity of each of the three sailing vessels.

The results of these calculations are given in Table 1 where a comparison is made with a motor-ship designed for 14.75 knots (vessel D) and a motor-ship designed for 10 knots (vessel E).

Table 1 Average Service Data

Ship	A	B	C	D	E
Cargo Dwt. Coeft.	0.728	0.683	0.512	0.661	0.706
Cargo Capacity (tonnes)	15 990	15 000	12 270	13 000	14 900
Average Sea Speed (kn)	7.9	9.3	12.6	14.1	9.5
Annual Freight Capacity (tonnes)	316 600	345 000	310 400	436 800	348 700

The average sea speeds quoted here make some allowance for speed losses due to rough weather and represent all seasons average values over both east and west bound voyages. It is interesting to note that the average sea speed of the catamaran vessel (C) is significantly higher than for the two monohulls (A) and (B). However, the extra weight of the bridge deck structure and the larger rig of this vessel reduces her cargo deadweight capacity to the point where her annual freight capacity is actually less than the other two sailing vessels. It can thus be concluded without any further ado that a large sailing catamaran would not be economically competitive with a monohull vessel. A corollary would be the assertion that improvements of sailing vessel performance will come from developments of rig rather than the adoption of unorthodox hull configurations.

#### Capital and Annual Operating Costs

Nobody has actually built and operated large sailing vessels of the type considered here, so that figures for construction costs and operating costs must inevitably be rather speculative. In particular it may be presumed that ancillary power would be used fairly freely for sail handling purposes if only because individual sails would be too large to manhandle in the traditional way; consequently manning levels can be on a more modest scale than was usual at the beginning of this century. However, without operating experience precise crew requirements cannot be specified. Similarly it can be expected that, in the long term, cargo handling methods would be adapted to suit the ship type to obtain the port turn round times expected of a modern cargo vessel. This could possibly be achieved by some form of roll on roll off arrangement which would not be adversely affected by the presence of the rig. Never the less, port turn round times must be in some doubt at this stage.

Construction costs for the rig, especially for the wing sail rigs, are also speculative. The best that can be done is to base material and labour costs on the estimated weight and to allow a reasonable figure for the costs of the auxiliary machinery required for control purposes.

Insurance rates and port charges appropriate to a sailing vessel are unknown. It was assumed that these could be based on capital cost and cargo deadweight capacity alone without regard to ship type. In the short term neither of these assumptions is likely to be true, but there is no obvious long term reason why sailing vessels should be at a disadvantage vis-a-vis a motor-ship in this respect.

Bearing in mind the uncertainties mentioned above it is possible to make cost estimates for the five vessels considered in this section on a uniform basis by making use of the data given in Refs. 4, 5 and 6. The data was arbitrarily scaled by a factor of 2.5 to yield costs equivalent to today's prices. The overall summary of these estimates is given in Tables 2 and 3.

Table 2 Capital Costs (€lm x)

Ship	A	B	D	E
Hull	1.96	2.01	1.71	1.82
Rig/Machinery	0.43	0.71	0.81	0.56
Other costs	0.40	0.45	0.51	0.41
Total	2.79	3.17	3.03	2.79

The other costs listed in this table include research and development costs, shipyard establishment charges and owner's expenses. It can be seen that these figures are closely similar for both sailing and motor vessels with the two ships with the higher service speed (in relation to their type of propulsion) being more expensive because of higher rig/machinery costs.

Table 3 Annual Operating Costs (£1000 x)

Ship	A	B	D	E
Fuel	31	21	503	143
Other Costs	344	314	430	377
Total	375	335	933	520

The other costs item in this table includes crew wages and subsistence, maintenance, stores and supplies, port and bunkering dues, insurance and overheads. The fuel cost figure is based on a price of £50 per tonne. It can be seen from this table that the two motor-ships would be distinctly more expensive to run than the sailing vessels and that fuel costs at current prices represent more than half the annual operating cost of the faster motor vessel.

## Overall Economic Performance

The overall economic performance of the four ships now being considered can be judged in terms of two figures. These figures are the Capital Return Factor (CRF) and Minimum Freight Rate (MFR). Following Benford (Ref. 7) CRF is defined as:-

$$\text{CRF} = \frac{\text{Revenue} - \text{Operating Costs}}{\text{Capital Costs}}$$

In the table below CRF is expressed in percentage terms. The level of CRF at which the ship begins to be profitable depends on the interest charges accruing to loans used to finance construction and hence depends on the particular financial arrangements made by the company. It is assumed here that the break-even point corresponds to a 15% CRF value. The freight rate (expressed in units of £/tonne/voyage) required to yield this CRF value is the quoted MFR figure. The revenue has been based on the assumption of a full cargo load. With this assumption the capital return factor varies linearly with freight rate. In Table 4 CRF values are given for two arbitrary values of freight rate (£2 per tonne and £5 per tonne) which span the typical range of freight rates obtainable in recent years.

Table 4 Economic Analysis

Oil Price Per Tonne	Ship	A	B	D	E
£30	MFR	2.40	2.24	2.64	2.40
	£2 CRF	10.8	12.4	5.7	9.9
	£5 CRF	44.8	45.0	49	47.4
£50	MFR	2.41	2.26	3.10	2.57
	£2 CRF	10.3	12.1	-1.0	8.0
	£5 CRF	44.3	44.7	42.3	45.0
£70	MFR	2.45	2.28	3.60	2.73
	£2 CRF	9.8	11.9	-7.7	5.8
	£5 CRF	43.9	44.5	35.7	43.3

With the current depressed state of the freight market and bunker fuel at about £50 per tonne cargo vessels are currently operating very close to the MFR rate and have been doing so for the past year. There is no immediate sign of any improvement.

Table 4 shows that while these conditions persist the sailing vessel can continue to trade profitably whilst the 15 kn motor vessel is trading at a loss; the 10 kn motor vessel is more profitable than the 15 kn vessel, but not as profitable as either vessel under sail. Under conditions existing prior to the oil crisis freight rates were generally higher and oil prices much lower at round £12 per tonne - conditions which would make the 15-18 kn motor vessel the most profitable.

One complicating factor is that the faster motor ship may be able to attract cargoes at a higher freight rate than her slower sisters. Whether the extra premium that could be charged would



compensate for the higher operating costs is difficult to judge. Ship D and Ship B would each have a CRF factor of 20% with fuel at £50 per tonne at freight rates of £3.45 and £2.73 per tonne respectively. This means that to obtain the same profit margin the 15 kn motor vessel would need to attract cargoes from the sailing vessel whilst charging a 25% higher freight rate. How successfully this could be done might well depend on the state of the market and the nature of the cargo concerned.

The broad conclusions from this economic analysis are that in current circumstances

- (a) The economic speed of a motor-ship may well be depressed to a point at which such a vessel offers no advantage in speed over a sailing vessel. In both cases the average sustained sea speed would be of the order of 9-10 kn.
- (b) At this sustained sea speed the sailing vessel could represent as profitable an investment as the equivalent motor-ship.

One would need a crystal ball to determine whether the current economic recession is purely a temporary set back or more long term; to determine whether other prices will rise to restore the relative value of oil fuel to its pre crisis level; to determine whether the future lies with a small number of large nuclear ships; to determine the nature of future governmental policies on oil conservation and so on. The most that can be said without the aid of such a crystal ball is that it is no longer impossible to conceive of circumstances in which wind powered ships might compete on economical terms, and hence there is an excuse for an examination of the technical characteristics such a ship might have.

#### Part B Performance Estimates for Various Wind Powered Vessels

A new generation of wind powered vessels could clearly be fitted with the same kind of rig as adopted by the large barques and schooners at the turn of this century. These ships, by modern sailing standards, were poor performers to windward, to the detriment of their average sea speed, their manoeuvrability and safety in restricted waters. There are several possible alternative rigs, each with its own particular characteristics, which could provide a more effective overall propulsion system for a wind powered cargo vessel.

The proposals considered in this paper are:-

- (1) The Prolss Dynaschiffe rig
- (2) Various forms of rigid wing sail
- (3) A windmill propelled vessel with a water propeller
- (4) A Flettner rotorship

This list is obviously not exhaustive. For instance instead of using the windmill to drive a water propeller it would be possible to directly use the windmill in an autogyro mode. There may well be other basic propulsion systems for wind powered or wind assisted vessels.

For comparative purposes performance estimates have been carried out at Southampton for rigs (2), (3) and (4) in a wind strength Beaufort 8 whilst comparable data for rig (1) has been extracted from Ref. 1. Over the Atlantic route chosen, winds of this strength and above occur about 7% of the time and it is reasonable to design the non-reefable rigs to operate safely in this wind strength. In relation to the size of the vessel the 35 knot mean wind speed of Beaufort 8, for a 20 000 tonne vessel, is comparable to a 10 knot wind speed for a 12m yacht. This is thus not a particularly severe condition for such a large ship. Above this wind strength it would be possible to reduce rig loads progressively by reducing the angle of attack of the wing sail, by feathering the windmill blades or reducing power input to the rotorship rotors.

For the purposes of estimating all seasons average sea speeds the performance estimates for a simple wing sail rig were also carried out over a range of Beaufort numbers from force 2 to force 9. In these estimates no direct allowance was made for hull resistance increases due to wave action, but in averaging sea speeds over a typical twelve month period appropriate speed reductions were incorporated.

In the course of these calculations it became evident that each of these rigs had its own distinctive features. For instance the windmill rig is capable of driving the ship directly to windward without the need for tacking whilst the very high lift coefficients capable of being generated by Flettner rotors are only usable when running before the wind.

The calculations were carried out for a common hull using resistance data derived from Ref. 2. The principal dimensions of the hull were chosen to be

Length B.P.	150m	Displacement	21 000 tonne
Beam Mld	29m		
Load draught	8.5m	15° heeling moment	300 MNm

The comparative sizes of the rigs that were presumed to be fitted to this hull are shown in Figs. 1a to 1e. Fig. 1a is the Dynaschiffe rig as quoted in Ref. 1. Fig. 1b is a single wing sail with a symmetric NACA 0012 section designed to produce a maximum heeling moment of 300 MNm on the wind. Fig. 1c is a two masted rig using high lift slotted wing sails of approximately equivalent performance to 1b. Fig. 1d represents a windmill rig designed to produce the same reaching performance as rig 1b. Finally, Fig. 1e is a Flettner rotorship with rotors designed to absorb 500 kW.

The Dynaschiffe performance data was taken from Ref. 1 whilst performance estimates for the other rigs made use of the hull characteristics given in Fig. 2.

#### The Prolss Dynaschiffe

The Dynaschiffe has been the subject of extensive wind tunnel testing at Hamburg University and towing tank data for a suitable hull on which to mount the rig has been obtained in the HSVA tank (also in Hamburg). In Ref. 1 Wagner produces performance estimates for a 21 000 tonne vessel using this rig over a range of Beaufort numbers 2-9.

In essence this rig is a square rig without headsails or staysails. The particular features of the rig are that the sails are bent to the yards at both the head and the foot of the sail, whilst the yards are curved so as to produce the appearance of a single high aspect ratio, cambered, fully battened sail on each of her six masts.

The concept has some similarities to the traditional rig of a junk.

The aerodynamic requirement for a rig designed to achieve good windward performance is that the rig should have a low minimum drag angle  $\epsilon_A = \tan^{-1} (C_D/C_L)$ . In fact the angle between the relative wind and the vessels track ( $\beta$ ) is simply related to the angle  $\epsilon_A$  and the corresponding hydrodynamic drag angle  $\epsilon_H$  since

$$\beta = \epsilon_A + \epsilon_H$$

Fig. 3 shows the sail characteristics of a number of different sail types. Those for the wing sails and the Bermudan yacht mainsail apply at all relative wind angles. Those for the barque and Dynaschiffe apply to  $\beta = 60^\circ$  only since interference effects in multimasted rigs depend on relative wind angle. The chosen value of  $\beta$  is typical of close hauled performance of these two rigs.

It can be seen that the Dynaschiffe rig represents a big improvement over a conventional barque rig both in respect of maximum  $C_L$  values that can be produced and in terms of the minimum drag angle. It is clear from Fig. 3, however, that the minimum drag angle is still significantly higher than the alternative single sailed rigs. The minimum drag angles are as set out below in Table 5.

Table 5 Minimum Aerodynamic Drag Angles

Rig	Min. Drag Angle
Rigid wing sails	5°
Bermudan Main	9°
Dynaschiffe	20°
Barque	37°

#### Rigid Wing Sail Rigs

The basic fault with the Dynaschiffe rig is that the interference due to the downwash effects of the forward masts progressively degrades the performance of succeeding masts. Thus the rig has a very high induced drag that can only be reduced by using fewer masts. The limits of this process is to set a single sail as shown in Fig. 1b. This diagram shows a single sail of 80% of the plan area of the Dynaschiffe rig, so chosen that the heeling moment produced to windward in a 35 knot true wind is within the 300 MNm righting moment produced by the hull at 15° heel.

Strength considerations dictate that a single sail of that size would need to be an all metal structure and even that might very well be difficult to erect. Some preliminary design calculations indicate that an aluminium structure similar in layout to an aircraft wing would have reasonable scantlings when designed to sustain the maximum heeling moment. The rig would weigh 850 tonnes compared to a total rig weight of 370 tonnes estimated for the Dynaschiffe rig. This weight aloft would raise KG by about 2m compared to the Dynaschiffe rig, but an adjustment in beam from 21m to 29m would ensure that stability is not impaired.

Since the rig is required to sail on both tacks a one piece wing sail would need to be symmetric and would, consequently, stall at a comparatively modest angle of attack. 'C' class catamaran racing has produced a number of more elaborate wing-sails such as that illustrated in Fig. 1c based on a design by Hubbard for 'PATIENT LADY II' (see Ref. 8). This device has a 'high lift' wing section consisting of three symmetric aero-foils set nose to tail. The assemblage can be adjusted to control overall camber ratios and the gaps between the foils can be used as slots to prevent stalling at much higher  $C_L$  values than can be achieved with a single symmetric foil. The trailing edge section can be split into several panels independently controllable to take account of the change of apparent wind direction with height above the deck. This twist in the apparent wind vector is particularly evident on a broad reach.

A high lift slotted wing-sail offers no advantage close-hauled where performance depends on minimum drag angles. It does offer advantages when reaching.

#### The Windmill Ship

From time to time suggestions appear in the yachting press for the use of windmills as a source of propulsive power. Most of these articles are not intended to be taken seriously, but never the less, such a device could be used for propulsion purposes and, on paper at least, could have several attractive features. In order to assess this form of propulsion performance calculations were carried out for a single screw vessel with a fixed pitch water propeller driven by a variable pitch windmill through a suitable gear train.

Although there are publications dealing with the use of windmills for electrical power generation (for instance Ref. 9) these do not contain enough data on rotor performance for present purposes. In land applications a windmill will be designed for maximum power output regardless of rotor drag, whereas for ship propulsion purposes the net propulsive force (to windward at any rate) is the difference between water propeller thrust and windmill rotor drag. As it happens the operating condition that corresponds to maximum propulsive effort is at a much higher rotor pitch setting than that corresponding to maximum rotor power output.

In order to generate windmill performance data over a sufficiently wide range of operating conditions, blade element momentum calculations similar to those used in marine propeller design were carried out for a four bladed windmill rotor of blade area ratio 0.25.

At a number of advance coefficient values  $J = V_A/nD$  in the range from  $J = 0.50$  to 4.0 calculations were carried out to determine the optimum efficiency condition and the corresponding values of rotor drag coefficient  $K_R$ , power coefficient  $C_p$  and

pitch/diameter ratio. The results of these calculations are presented in Fig. 5. The coefficients presented in this diagram are

$$\begin{aligned} \text{Rotor Drag Coefficient} & \quad K_D = \frac{\text{Drag (R)}}{\rho n^2 D^4} \\ \text{Rotor Delivered Power Coefficient} & \quad C_P = \frac{\text{Delivered Power (P}_D)}{\rho V_R^3 D^2} \\ \text{Efficiency} & \quad n = \frac{P_D}{R \cdot V_R} = \frac{2\pi n Q}{R \cdot V_R} \\ \text{Rotor Torque} & \quad = Q \end{aligned}$$

A glance at the aerodynamic/hydrodynamic vector diagrams for this rig (Fig. 9) makes it obvious that when working to windward the rotor drag force does not produce a large heeling moment whilst on a beam reach rotor drag is no higher than wing-sail forces on the same point despite the very large size of the rotor. Thus the heeling moment produced is not a limiting feature of this rig.

As a design starting point a windmill design was sought which, in combination with a suitable water propeller, would produce the same reaching performance in Beaufort 8 as the wing-sail rig. It was assumed throughout the performance calculations that a 10% loss of power occurred in the gearing between the windmill and the propeller and due allowance was made for wake and thrust deduction effects at the propeller. The required performance is obtained by a windmill rotor of 166m diameter, operating at an arbitrarily chosen  $J = 1.0$ , geared to a Gawn series propeller 4.5m dia., 0.67 P/D, 0.65 BAR. The windmill operating condition is point B in Fig. 5.

The required windmill diameter is enormous and its structure would clearly pose problems. The diameter could in fact be reduced by about 6% by operating at the point of maximum power output ( $J = 0.70$ ) but this would be to the detriment of downwind performance.

One of the most interesting features of the rig is its ability to propel the vessel directly to windward, since the propeller thrust can exceed the windmill drag by a margin sufficiently great to achieve a useful speed through the water. In fact the performance calculations show that the two rigs which achieve the highest speed made good to windward in Beaufort 8 are the single wing sail and the windmill rig, both of which will achieve 13 knots  $V_{MG}$  compared to about 5½ knots for the Dynaschiffe. Thus this rig is very attractive in relation to windward performance both in terms of speed achieved and in the unique freedom from the need to tack. The windmill operating condition to windward corresponding to the highest net forward thrust is at point C in Fig. 5 at a much coarser pitch setting than required when reaching.

When running before the wind two propulsion conditions are possible with little to choose between them. One choice is to stop the windmill completely and allow the water propeller to idle. This implies an acceptance of the drag of the propeller in this condition. The second choice is to fine off the windmill

pitch below the point of maximum power output to the point where the residual power output is only sufficient to keep the water propeller turning in a no thrust condition. This condition (point A of Fig. 5) is also a condition of high rotor drag and in the downwind condition it is the rotor drag which provides the propulsive effort - the water propeller is merely an encumbrance.

There are a number of features of windmill propulsion that are worthy of note:-

- (a) The windmill rotor has to operate over a very wide range of pitch setting from  $P/D = 2.6$  down to  $P/D = 0.30$ .
- (b) The windmill must operate at very low rotational speeds (3 to 10 rpm in Beaufort 8) in order to optimise performance. This is the main reason for the very large rotor diameter involved.
- (c) The water propeller is operating over a narrower but much higher rev range (180 to 250 rpm in Beaufort 8). Moreover the gear ratio when driving a fixed pitch propeller is required to vary widely and continuously with apparent wind angle. This would probably imply the need for a C.P propeller as well as a C.P windmill rotor or some form of electric propulsion.
- (d) The high gearing up to the propeller might result in problems with system self-starting.
- (e) Torque losses in the gearing will adversely affect light weather performance.

#### The Flettner Rotorship

The last form of propulsion considered in this paper is the Flettner Rotorship which derives its propulsive thrust from the lift and drag forces developed on large rotating cylinders mounted above the hull. Two small ships were converted to this form of propulsion in the 1920s and one of these, 'Buckau' (680 tonnes), made a transatlantic voyage. She was reported to have achieved speeds of 5-6 knots in a 10 knot wind. These ships are described in Ref. 10. In the following ten years a number of experimenters made wind tunnel measurements of forces on rotating cylinders, amongst them Thom (Ref. 11). Ref. 12 contains an up-to-date bibliography on 'Magnus Effect' (i.e. lift produced by rotating cylinders).

This type of vessel is strictly speaking a wind assisted ship rather than a wind powered one since significant amounts of power are required to maintain the cylinder rotation. Performance estimates soon reveal that the performance achieved depends on the amount of power used to rotate the cylinders. A quite arbitrary decision to limit power input to 50% of the power required to propel a motor ship at a speed of 9 knots resulted in speed predictions in Beaufort 8 wind strength compared very well with those achievable by the other rigs investigated. 9 knots is likely to represent a year round average sea speed for this vessel so that the power input selected is substantial in relation to average performance, although it represents no more than 3% of the power normally required to propel the vessel at the maximum achieved speeds (23 kn). In mitigation it is true that the use of full rotor power in light weather could result in favourable light weather performance and hence a relatively high

average sea speed. It would need an investigation of performance over a full range of conditions before an assessment of the economics of this form of propulsion could be made.

The wind tunnel data, unfortunately, has all been obtained at subcritical Reynolds numbers because of the small cylinder sizes used. This results in drag coefficients which are patently too high at zero speed of rotation as can be seen from Fig. 6 (taken from Ref. 11) and relating to 2 dimensional cylinders. This is important only to the estimation of close hauled performance. Fig. 5 (also from Ref. 11) can be used for estimating the torque required to maintain cylinder rotation.

In Fig. 4,  $C_L$  is plotted as a function of  $C_D$  as calculated by adding an induced drag based on normal aerodynamic formulae. It can be seen from this data that very high lift coefficients can be produced by rotating cylinders. However, the limitation on performance due to the selected power input means that in practice these high lift coefficients can only be used running downwind when relative wind speeds are low. In Fig. 4 point A represents a closehauled operating condition, point B a reaching condition and point C a running condition.

The operating of a rotor ship with the wind astern is interesting. In this condition the lift generated by the cylinder acts perpendicular to the ship's track and hence does not provide a propulsive force - the propulsive force is entirely the result of the large induced drag coefficients produced by a high lift device. Although the rotorship is not particularly close-winded, it can achieve respectable speeds through the water on most points of sailing.

#### Comparison of the Four Rigs

The results of the performance calculations reported in this paper are summed up in Figs. 7, 8 and 9. Fig. 7 shows the performance of each rig as estimated for Beaufort 8 conditions plotted in a polar form with the radius vector representing ship speed as a function of angle from the true wind direction. From this diagram it can be seen that the Dynaschiffe rig represents a considerable improvement on a conventional square rig; but, even so, the rig does not perform very well to windward. The three more unorthodox rigs should perform better than the Dynaschiffe except on a broadreach and in particular offer a considerable improvement in speed made good to windward.

The best rigs to windward appear to be the wing sail and the windmill rigs. From Fig. 7 these both attain 13 knots VMG compared to  $5\frac{1}{2}$  knots for the Dynaschiffe. Speed alone is not the only criterion and in terms of close-windedness the windmill can sail directly to windward, the wing sail rigs could sail at  $30^\circ$  to the true wind whereas the other rigs are limited to about  $55^\circ$  to the true wind. The ability to sail close to the wind is very important for large ships in congested water such as the English Channel area or at the entrance of almost any port. In this respect the unique freedom from tacking enjoyed by the windmill rig has much to recommend it.

Fig. 9 shows the relative magnitudes of rig and hull forces for each rig when sailing (i) to windward (ii) reaching and (iii) running. The diagrams are all to the same scale and are annotated as follows:-

<u>Vectors</u>	<u>Notation</u>
Rig lift force	OA
Rig total force	OB
Hull side force	OC
Hull induced drag	CD
Hull total drag	CE
Hull total force	OE
Prop thrust (windmill rig only)	GH

An apparent wind vector triangle is also shown for cases (i) and (ii).

These diagrams show a number of features worthy of comment:-

The windmill rig at the correct pitch setting is subject to very small forces when close to the wind. In particular the side forces are so small that there is no need to provide a keel to prevent excessive hull induced drag values. This contrasts with the wing sail rig and the rotor ship both of which are presumed to be fitted with drop keels that are considerably more efficient than the bilge keels proposed for Dynaschiffe. There is a considerable draught penalty with the keels lowered.

The rotor ship rig is the only rig which can produce large forces downwind. In this condition not only is there a large driving force but also large side forces and heeling moment, so that the hull will be heeled over and making leeway when running before the wind. Like the windmill rigs lack of heeling moment to windward, the downwind heeling of the rotor ship is something outside normal sailing experience. However, as the force diagrams show, it is still the windward condition that produces the largest forces and heeling moments on the rig.

### Conclusions

The conclusions reached in this paper can be summarised as follows:-

- (i) From Part A current economic circumstances are such that commercial sailing vessels can expect to compete successfully with motor-ships for the first time since the beginning of this century.
- (ii) This situation may be a temporary one or it may turn out to be a continuing long term one; in which case large commercial sailing ships may well reappear.
- (iii) In terms of immediate practicality the Proless Dynaschiffe represents a modest development of earlier sailing ships and has already reached a sufficiently advanced stage for construction to be contemplated. Thus the first ships of a new generation of sailing vessels would be almost certainly of this type.
- (iv) There are several more advanced rigs which offer the possibility of an even better performance than the Dynaschiffe. These rigs are all sufficiently removed from existing experience to represent a much more difficult design problem, but each rig has its own distinctive features.
- (v) Even if the sizes were scaled down for constructional reasons to the point where the average sea speed were no better than the Dynaschiffe, these distinctive features may still be



attractive reasons for choosing one of the alternative rigs.

- (vi) In particular it is worth noting
  - (a) The superior performance to windward of the wingsail rig and the windmill rig
  - (b) The unique ability of the windmill rig to go to windward without tacking
  - (c) The possibility of superior light weather performance of the rotorship.
- (vii) If commercial sail does reappear one can foresee a period of innovation that would excite almost all professional engineers. This would be very gratifying to folk interested in sail, but will it happen?

#### Acknowledgements

The author acknowledges the assistance of Mr. S.B. Cox who carried out the economic calculations and the performance estimates for the wingsail rig. This work was done under the author's supervision as a final year honours degree project in Ship Science.

#### References

1. Wagner B. "Performance Prediction for Sailing Ships". (Fahrtgeschwindigkeitsberechnung für Segelschiffe) Hamburg University Report, 1974.
2. Taylor D.W. "Speed & Power of Ships". US Govnt. Printing Office, 1943.
3. Moor D.I., Parker M.N. & Pattulo R.N.M. "The BSRA Methodical Series - An Overall Presentation". Trans. R.I.N.A., Vol. 103, pp. 329-420, 1961.
4. Munro-Smith R. "Merchant Ship Design". 2nd Ed: Hutchinson, 1964.
5. Benford H. "Ocean Ore Carrier Economics & Preliminary Design". Trans. SNAME, Vol. 66, 1958.
6. Benford H. "Engineering Economy in Tanker Design". Trans. SNAME, Vol. 57, 1957.
7. Benford H. "Principals of Engineering Economy in Ship Design". Trans. SNAME, Vol. 73, 1963.
8. Scherer J.O. "Aerodynamics of High Performance Wing Sails". Proc. Chesapeake Sailing Yacht Symp. 1974, SNAME Chesapeake Section.
9. Putnam P.C. "Power from the Wind". Van Nostrand, 1948.
10. Flettner A. "The Flettner Rotor Ship". Engineering, Vol. 19, Jan. 1925.
11. Thom A. "Effects of Discs on the Air Forces on a Rotating Cylinder". Aero. Res. Com. R & M 1623 (1935). Also R & M Nos. 1018, 1082, 1520.
12. Swanson W.M. "The Magnus Effect: A Summary of Investigations to Date". Journal of Basic Engineering, 1961.

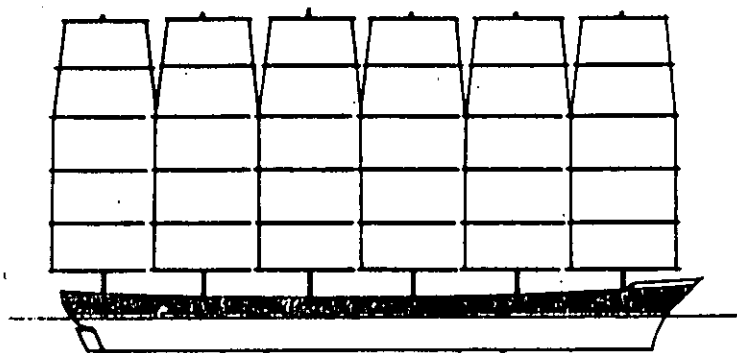

Dynaschiffe

FIG 1. a

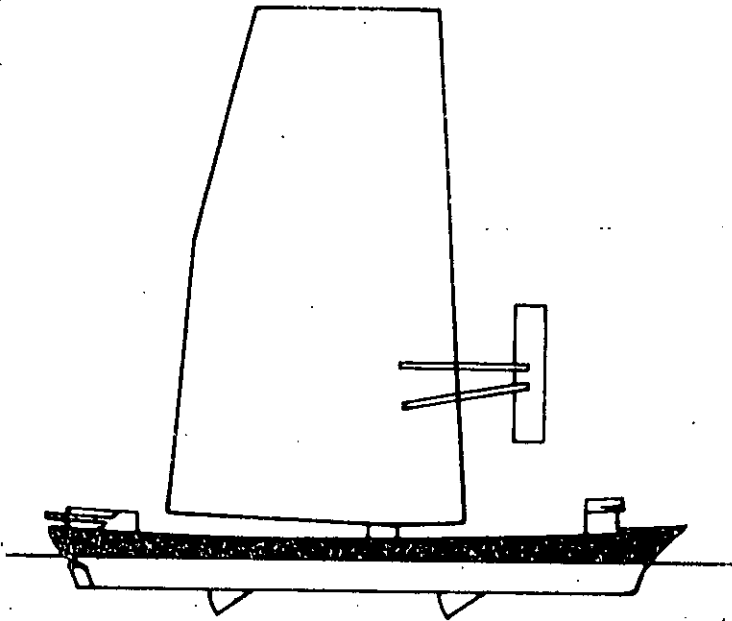

Simple Wingsail

1b

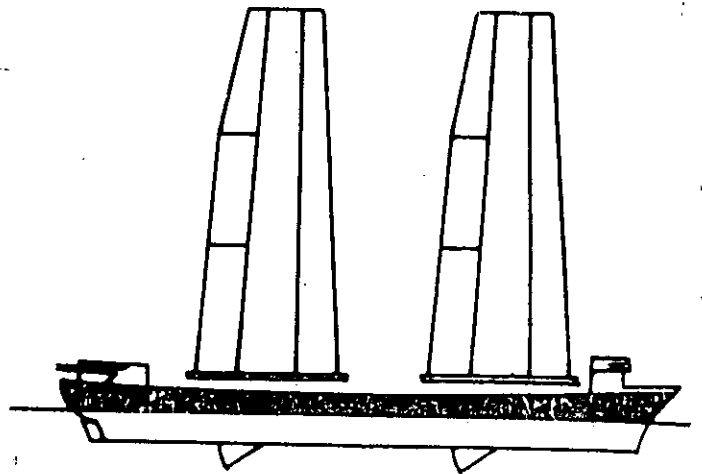

High Lift Wingsail

1c

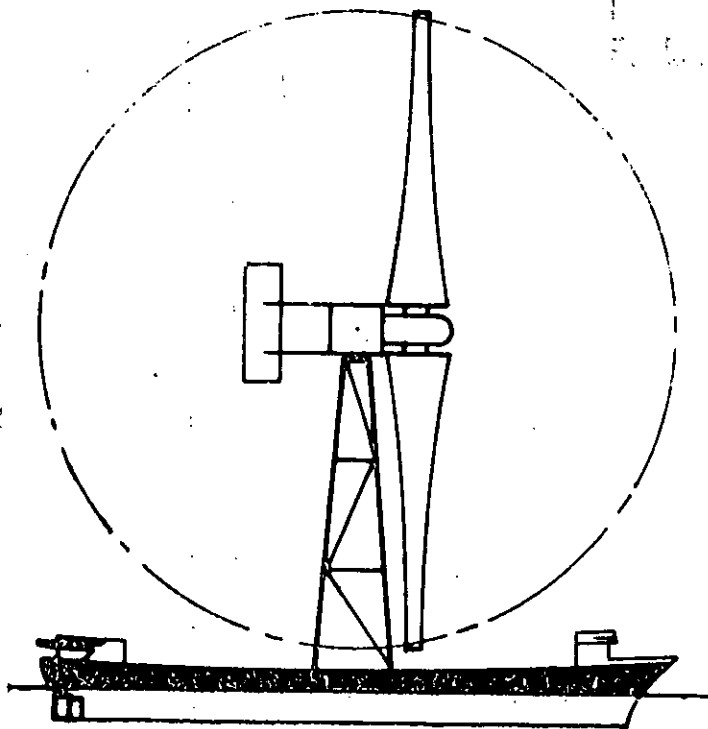

Windmill Ship

1d

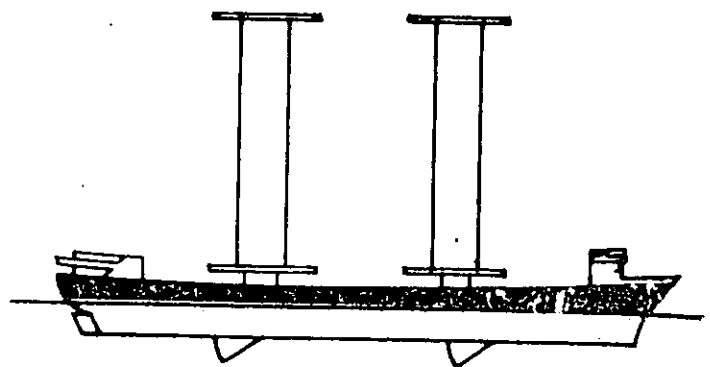

Flettner Rotorship

1e

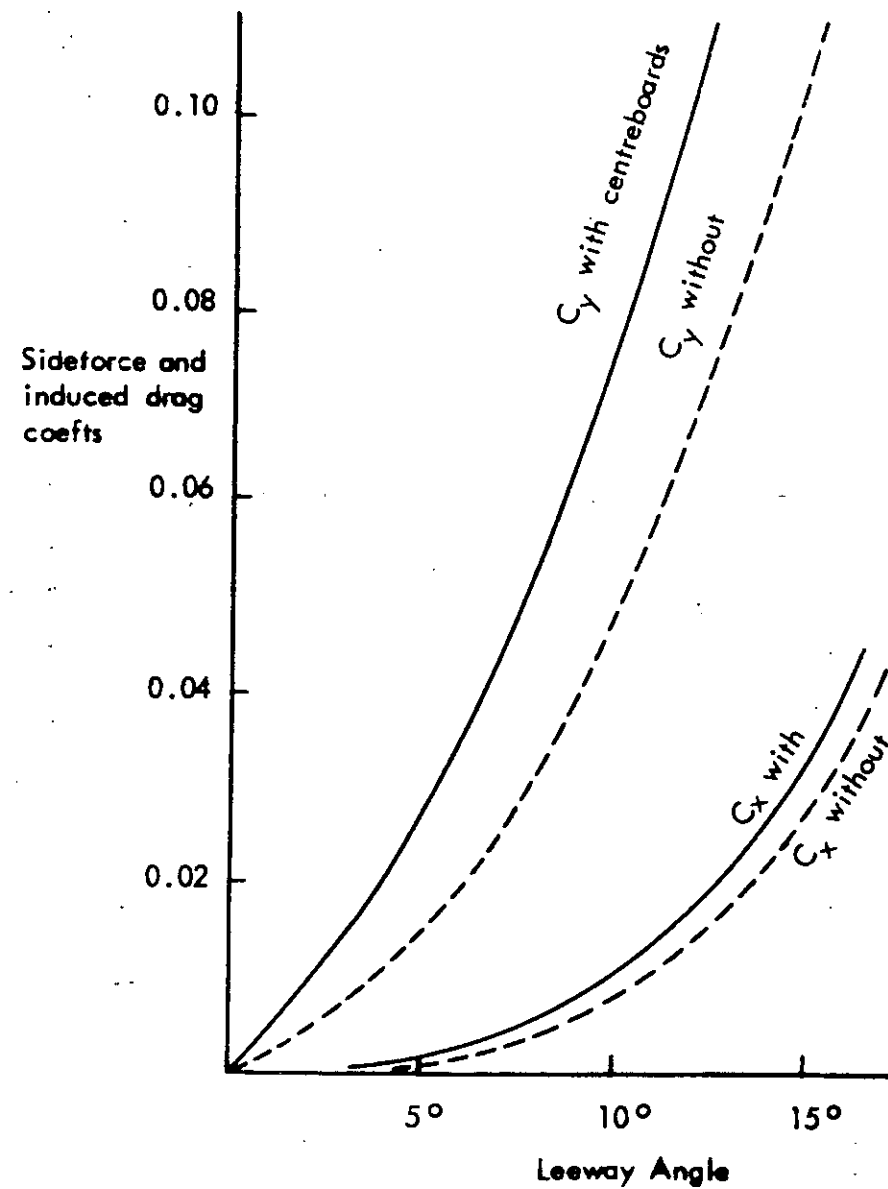
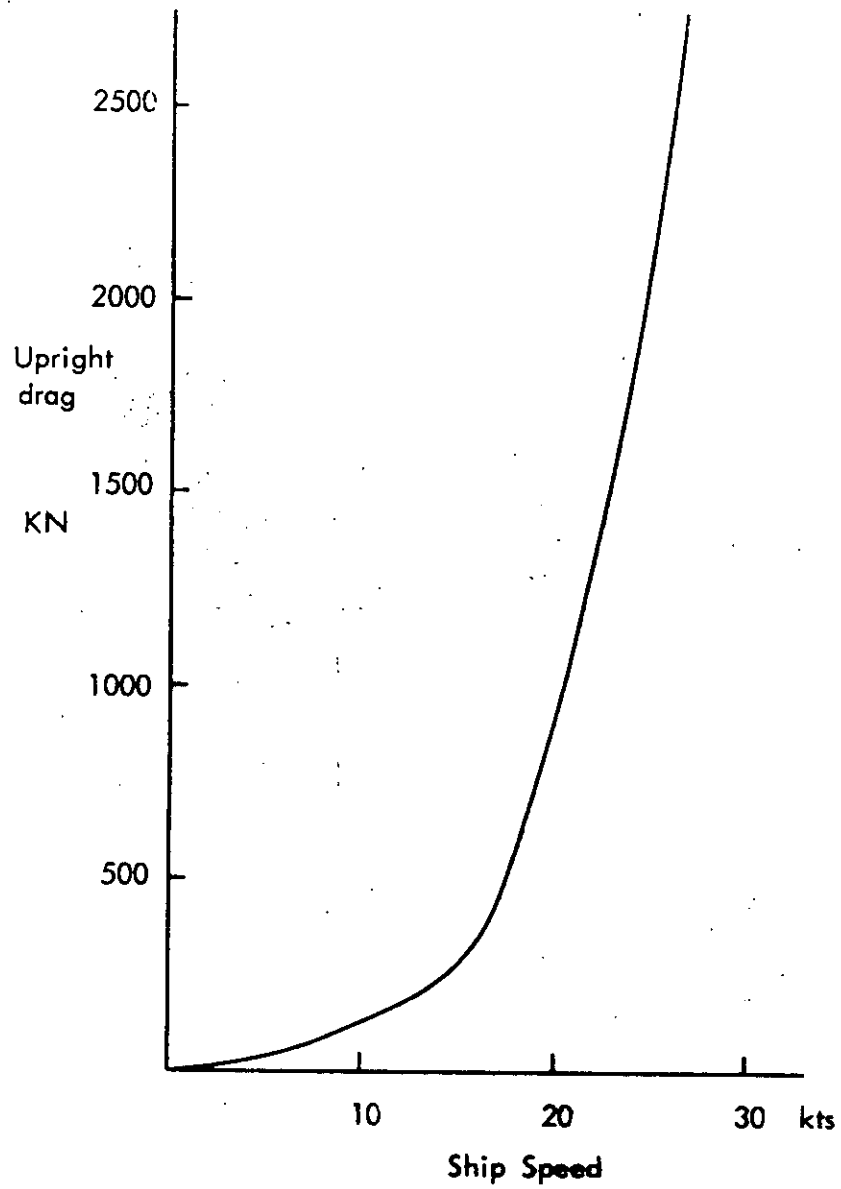

FIG 2

HULL CHARACTERISTICS

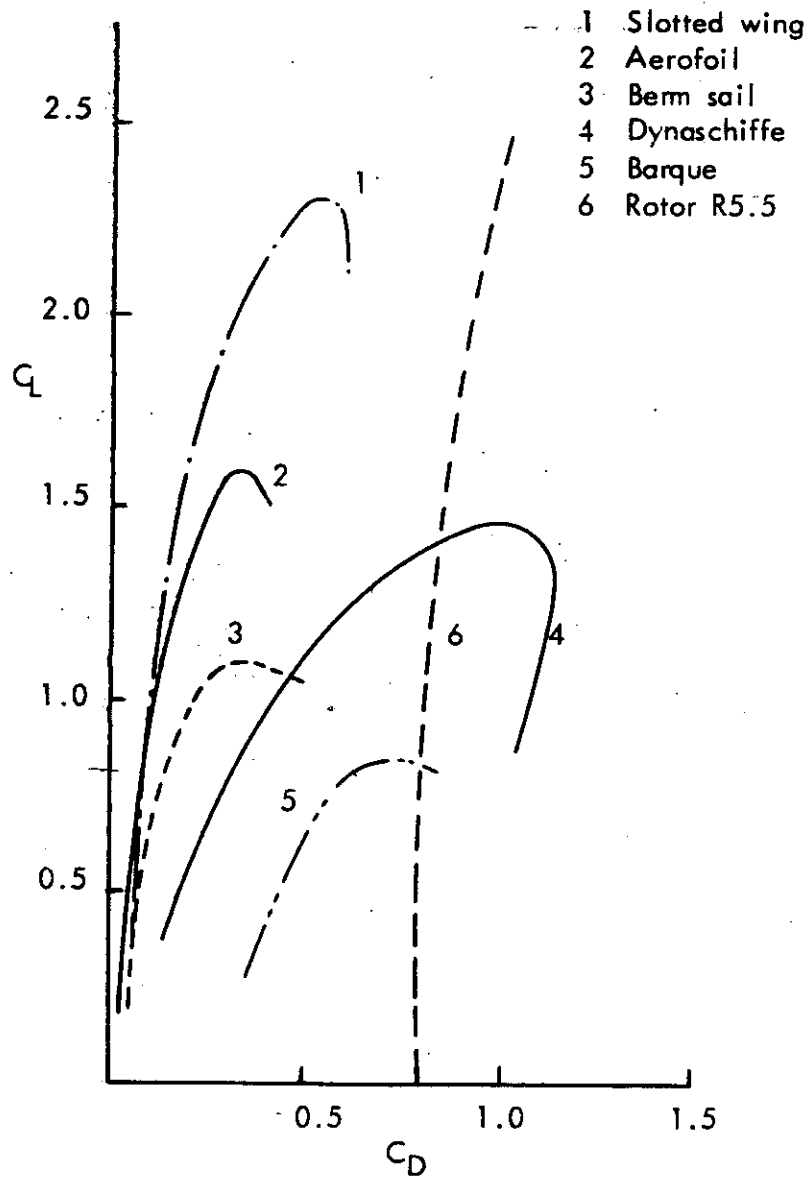

FIG.3. SAIL POLAR DIAGRAM.

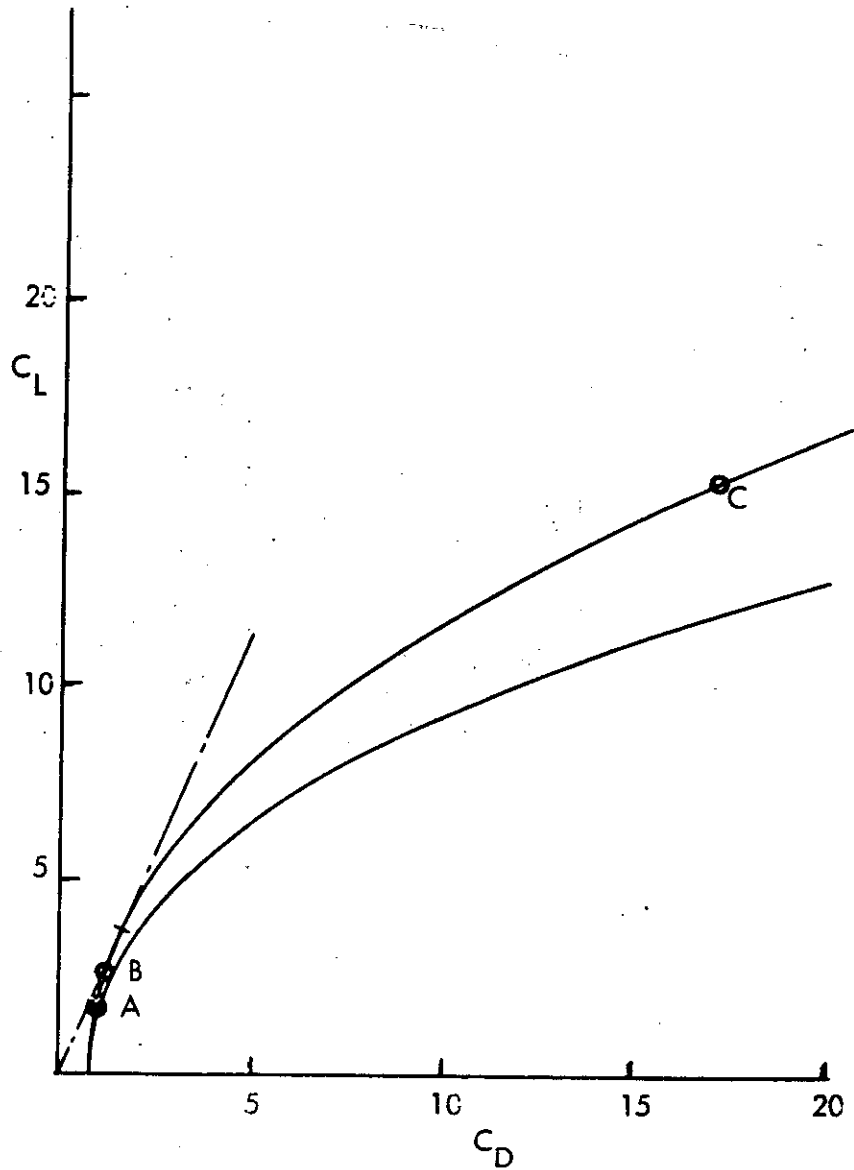

FIG.4. FLETTNER ROTOR.

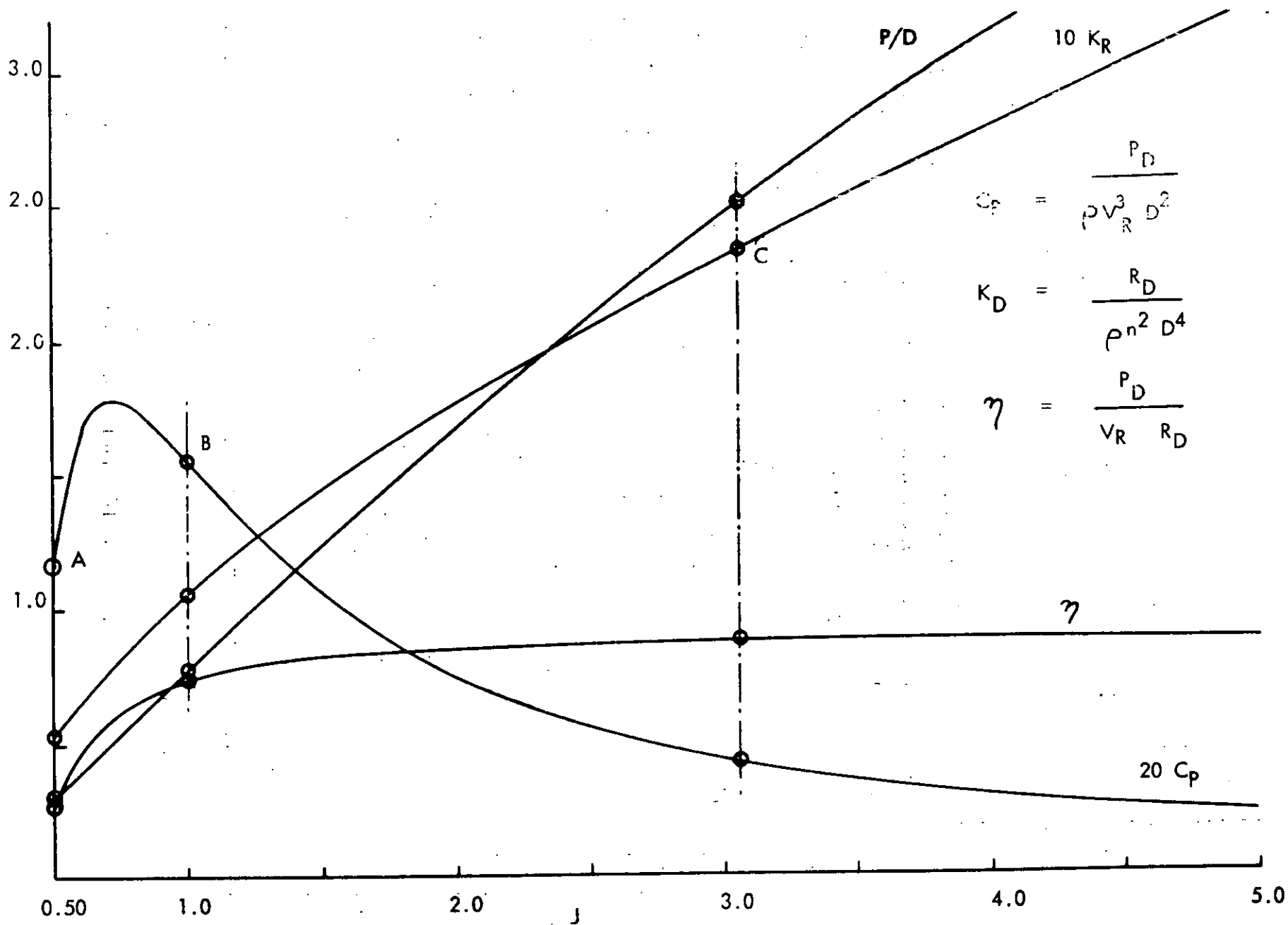
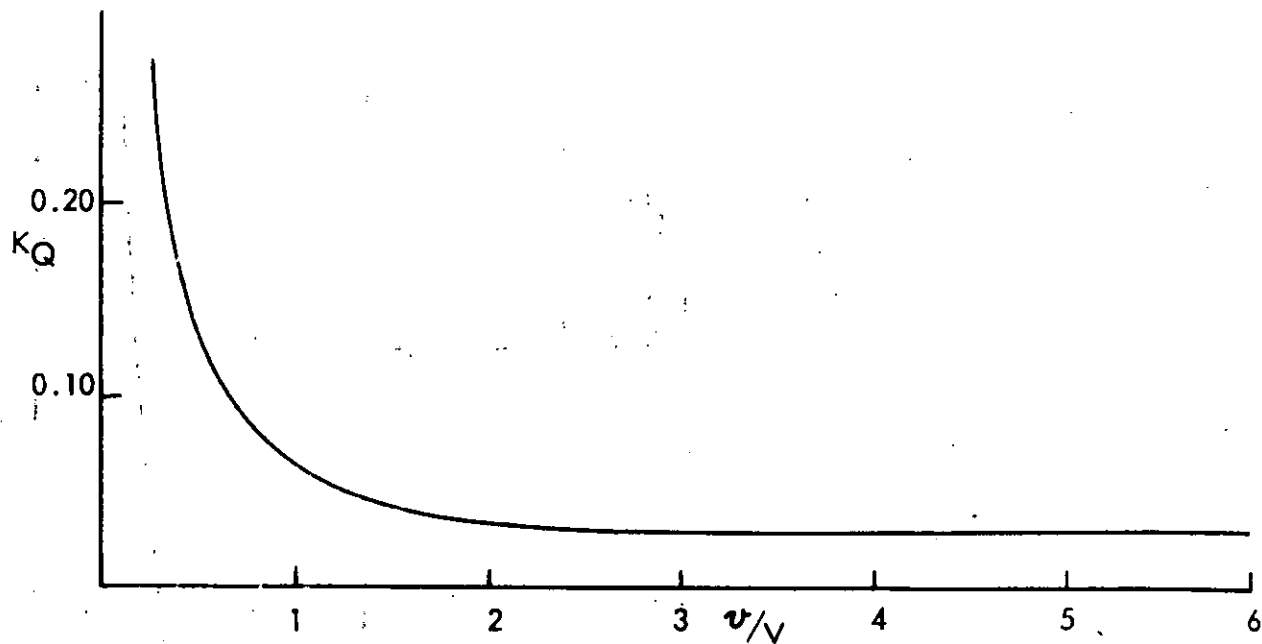

FIG 5 WINDMILL PERFORMANCE CURVES



ROTOR TORQUE CHARACTERISTIC

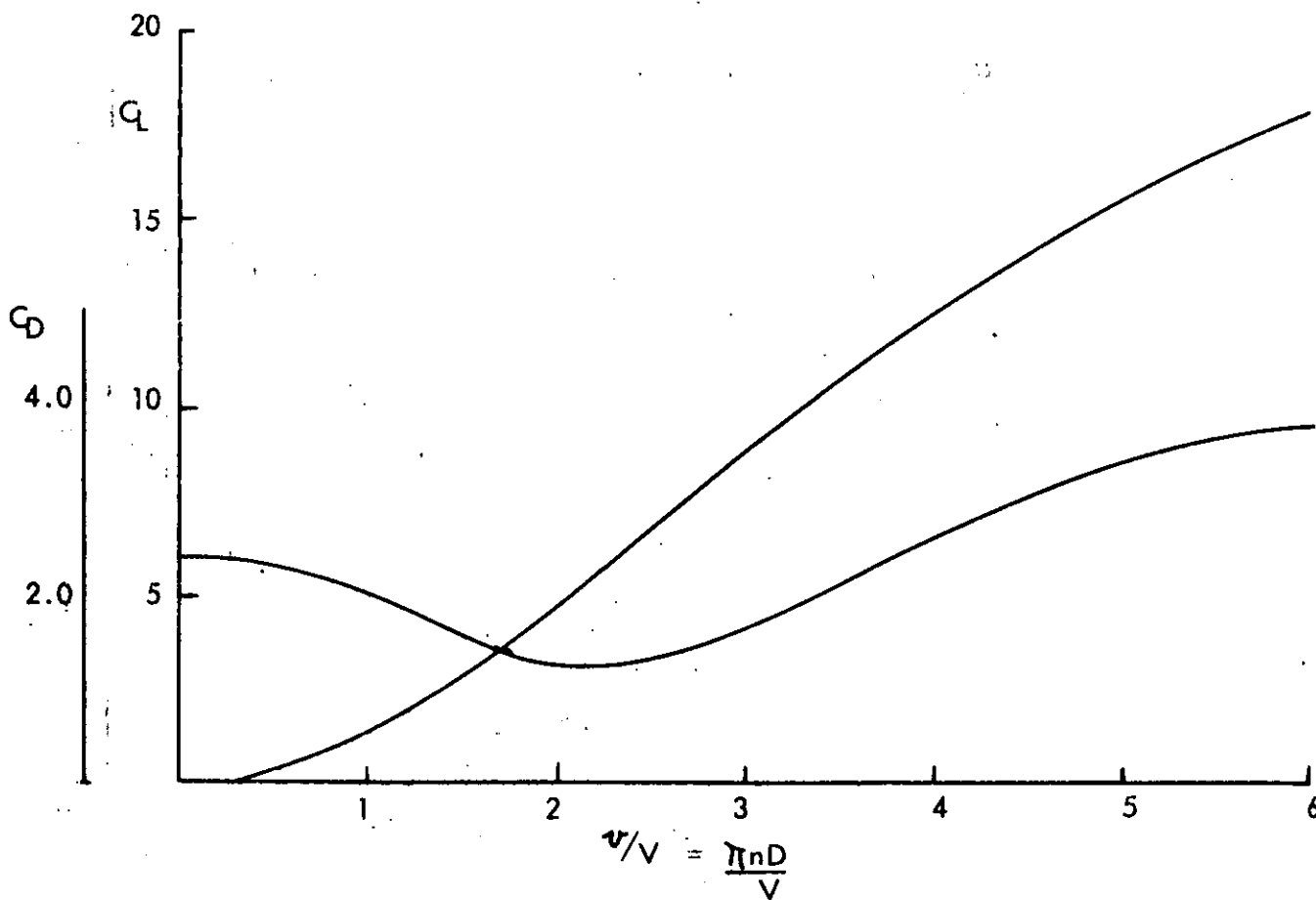

FIG 6 ROTOR LIFT AND DRAG CHARACTERISTICS

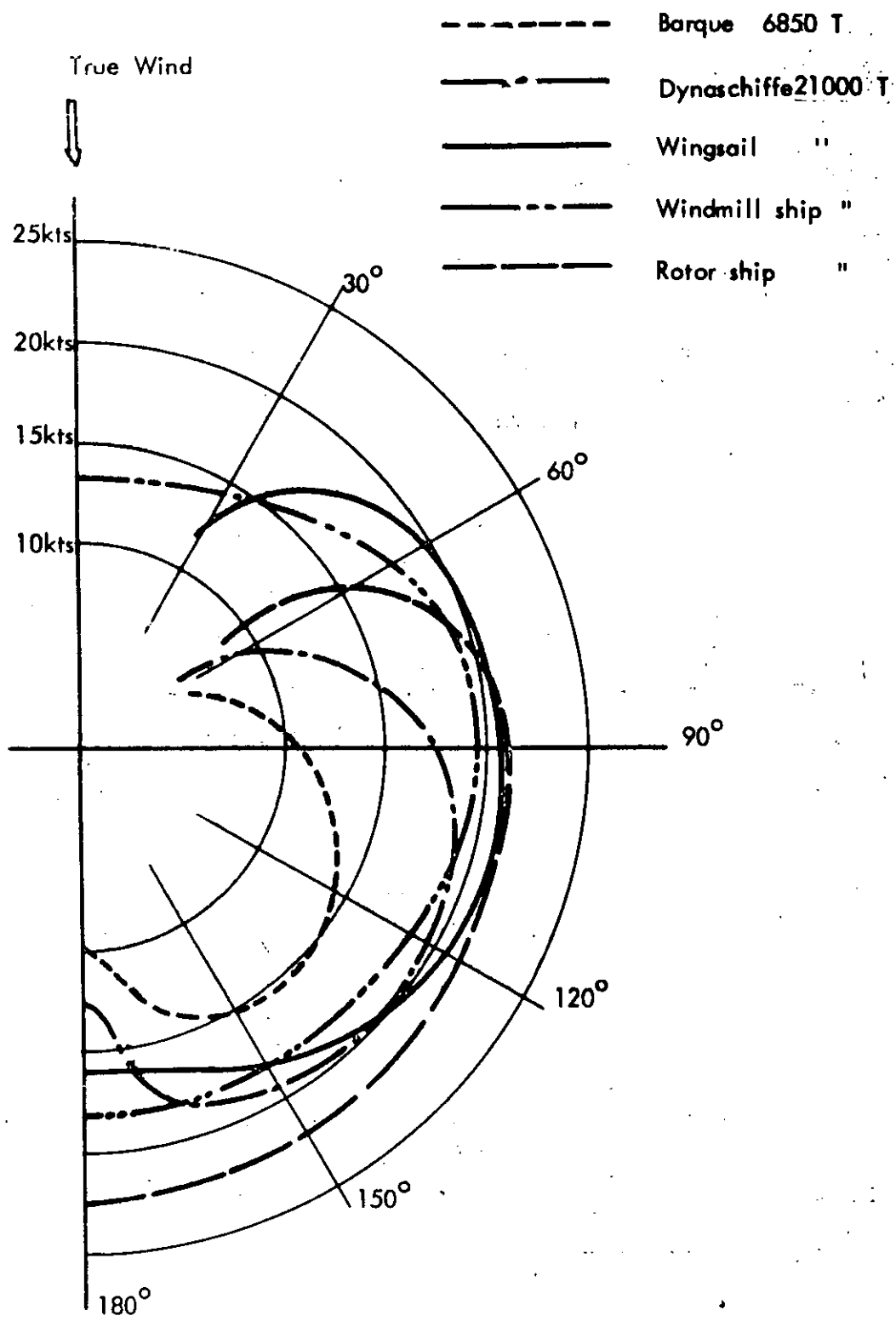

FIG 7 COMPARATIVE POLAR PERFORMANCE DIAGRAMS Bu 8.



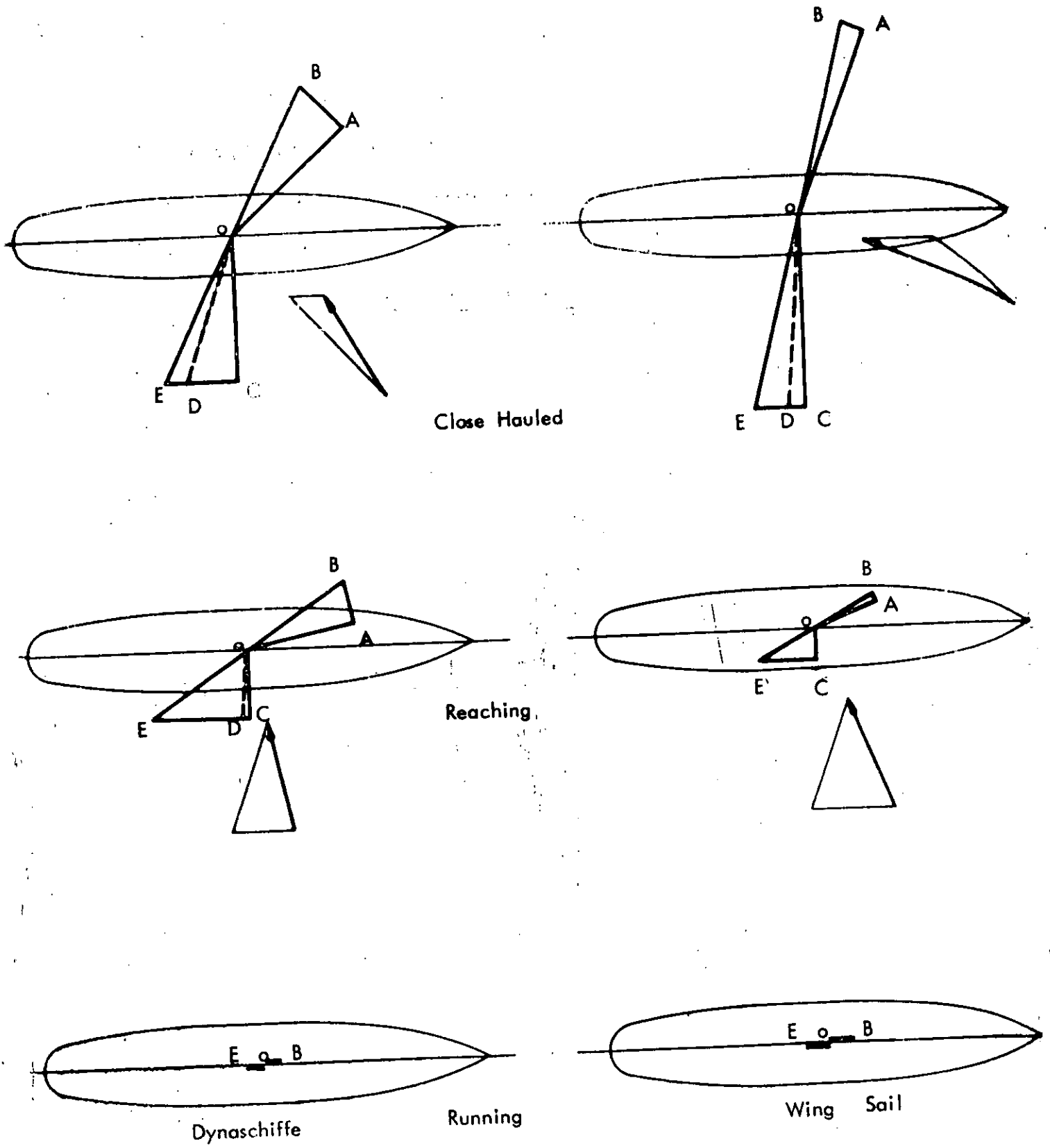
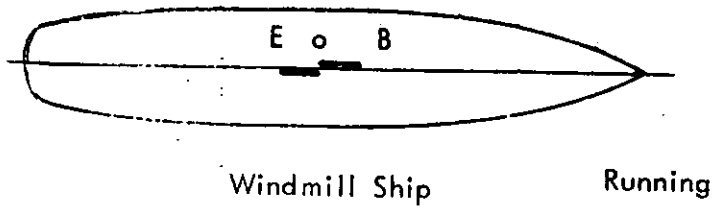
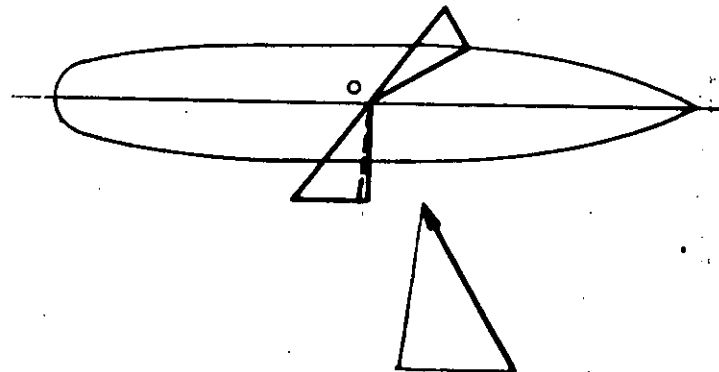
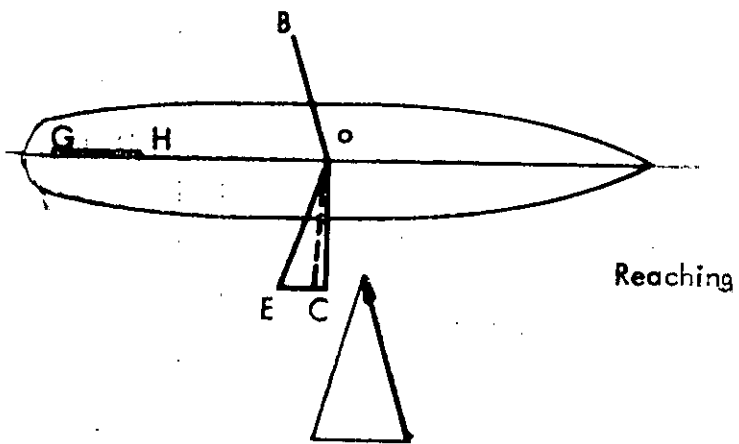
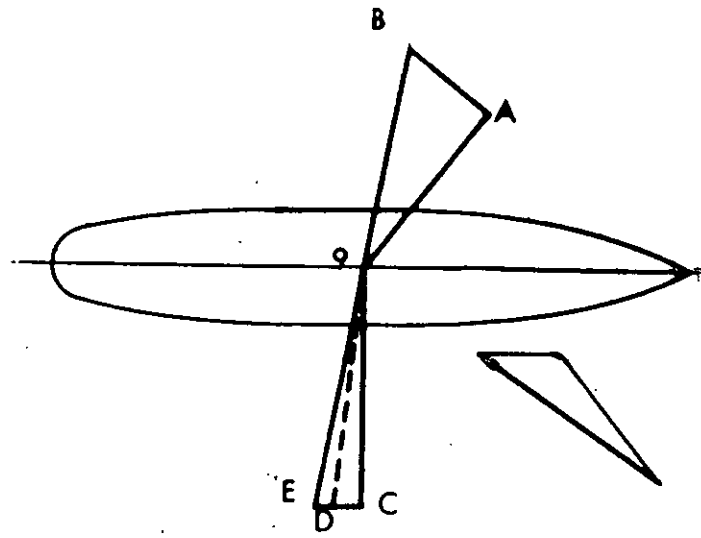
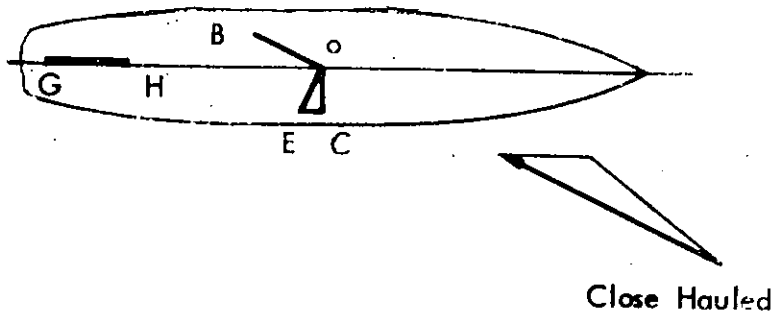
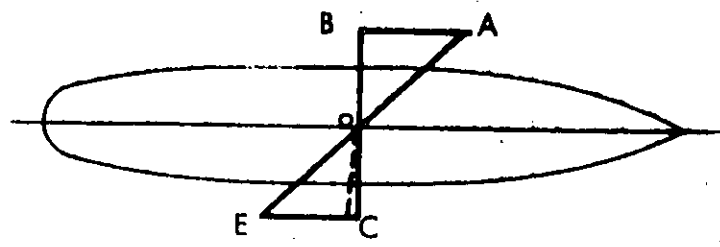

FIG 8



Running



Rotor Ship

FIG 9

ERRATUM

Page 12 Line 10.

'Fig. 5 (also from Ref. 11)' refers to the upper diagram on page 20 and not to the diagram on page 19.